

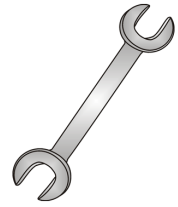

PRO-STEP™

Fitting Instruction



Issue 1

PRO-TVW15

Item	Qty	Description
A	1	PRO-TVW15 STEP
B	4	M14 x 45 Bolts & Nyloc Nuts
C	8	14 x 27 Flat Washers

1. Using Item B with Item C loosely fix the Towbar crossmember between each side arm at the forward mounting point only leaving the fixing loose enough to enable you to slide Item A through the open slot.
2. Using Item B with Item C fix Item A through the remaining fixing point.
3. Fully tighten all fixings ensuring the Towbar and Pro-Step are rigid, square and secure.

1

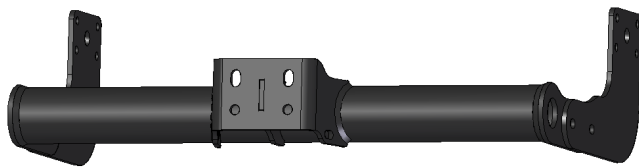

TVW15

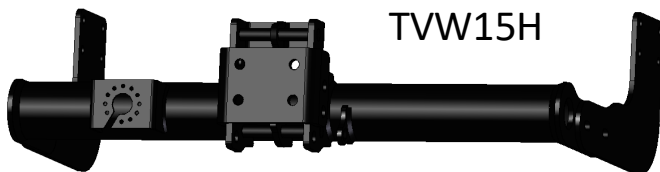

TVW15H

2

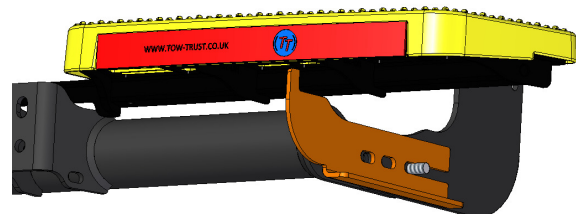
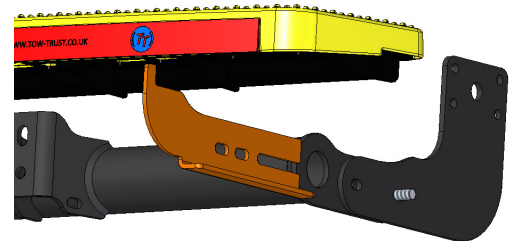

3

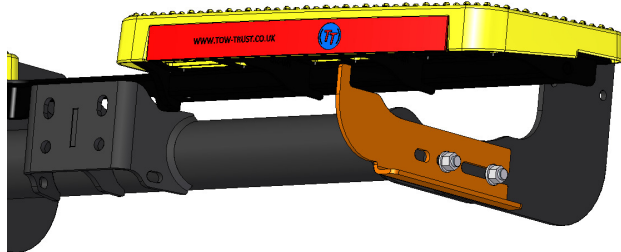

TVW15 ●
TVW15H ●

4

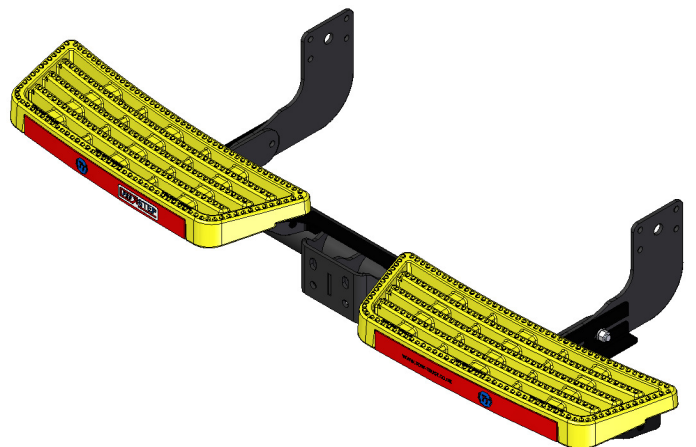

Note:

1. Nose load limits and vehicle manufacturers trailer / caravan weight limits must be observed.