

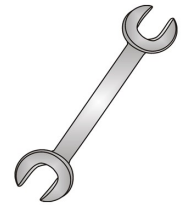

Tow-Trust Towbars

Important: Please read General Notes overleaf before fitting



Issue 3

TVW17VK AUDI Q7 2015> / AUDI Q8 2018> / PORSCHE CAYENNE 2018> / VOLKSWAGEN TOUAREG 2018>

Item	Qty	Description	Item	Qty	Description
A	1	TVW17 Crossmember	C	1	Flip Up Socket Plate (TTFP/LH)
B	1	6220 Detachable Neck	D	4	M12 x 25 Bolts (10.9) & S/P Washers
			E	8	M12 x 45 x 1.5 Bolts & S/P Washers
			F	4	M6 x 30 Bolts, Nuts & S/P Washers
			G	8	12 x 40 Flat Washers
			H	4	12 x 25 Flat Washers
			J	4	6 x 20 Flat Washers

AUDI BUMPER REMOVAL:

1. Remove two fixings securing the wheel arch liner and peel back to reveal one more fixing. Repeat both sides of vehicle.
2. Remove twelve fixings from the bumper lower edge.
3. Carefully unclip wheel arch trim to reveal two fixings. Repeat both sides of vehicle.
4. Q8 ONLY: Remove plastic trim from inside face on boot opening of each light cluster, this will reveal one bumper fixing. Remove each light cluster two fixings per light.
5. Carefully remove rear bumper, disconnecting any necessary wiring looms.
6. If fitted remove one sensor either side of rear impact beam.
7. Remove rear impact beam, this is not refitted with the Towbar assembly.

PORSCHE BUMPER REMOVAL:

1. Remove three fixings securing the wheel arch liner. Repeat both sides of vehicle.
2. Carefully unclip wheel arch trim to reveal two fixings. Repeat both sides of vehicle.
3. Remove fourteen fixings from the bumper lower edge.
4. Remove plastic trim from inside face on boot opening of each light cluster. Remove each light cluster two fixings per light.
5. Carefully remove rear bumper, disconnecting any necessary wiring looms.
6. If fitted remove one sensor either side of rear impact beam.
7. Remove rear impact beam, this is not refitted with the Towbar assembly.

VOLKSWAGEN BUMPER REMOVAL:

1. Carefully unclip wheel arch trim to reveal three fixings. Repeat both sides of vehicle.
2. Remove ten fixings from the bumper lower edge.
3. Remove one fixing by each light cluster.
4. Carefully remove rear bumper, disconnecting any necessary wiring looms.
5. If fitted remove one sensor either side of rear impact beam.
6. Remove rear impact beam, this is not refitted with the Towbar assembly.

TOWBAR INSTALLATION:

1. Using Item E with Item G fix Item A to the rear panel.
2. Refit the two sensors that were removed from the rear impact beam to Item A using Items F and Items J.
3. Fix Item B and Item C to Item A using Items D and Items H.
4. Fully tighten all fixings ensuring the Towbar is rigid, square and secure.
5. Cut the bumper as per the sketch on Page 2.
6. Refit the rear bumper.

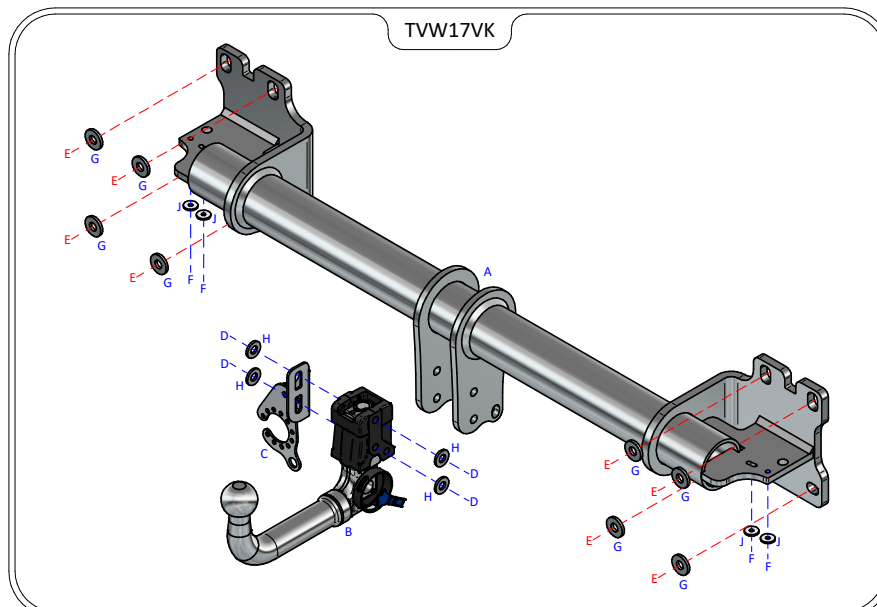

Note:

1. Torque Settings see notes overleaf.
2. Nose load limits and vehicle manufacturers trailer / caravan weight limits must be observed.

AUDI Q7

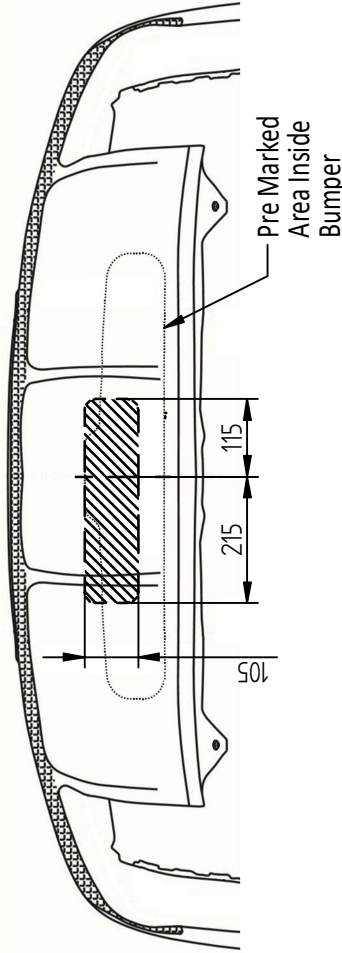

AUDI Q8

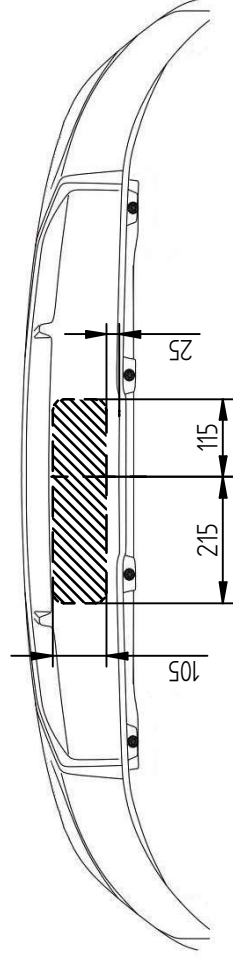

PORSCHE CAYENNE

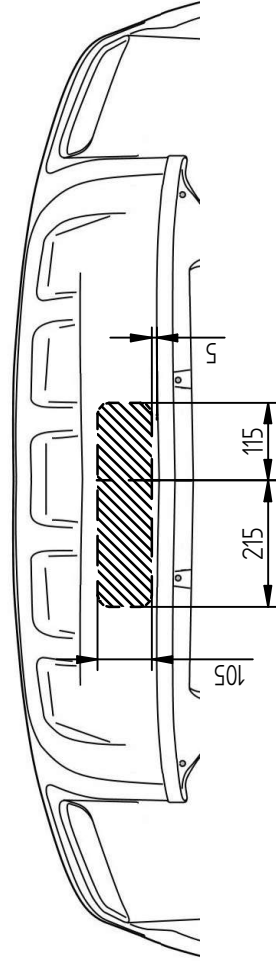

VOLKSWAGEN TOUAREG

